

Technical data sheet

Clamp clip, single, A2 metal pressure trough

Item number: 1159746



Suitable for all C profile rails with slot width 16–17 mm.
Clip, bolt and pressure trough all made of rust-proof stainless steel.



A2 Stainless steel

2B Bright, treated

Master data

Item number	1159746
Description 1	Clamp clip
Description 2	with metal pressure sump
Manufacturer	OBO
Dimension	40-46mm
Material	Stainless steel
Surface	Bright, treated
Surface standard	
Smallest sales unit	25
Unit of quantity	Piece
Weight	9.6 kg
Weight unit	kg/100 pc.
CO Footprint (GWP) Cradle-to-Gate	0,6113 kg COe / 1 Piece

Technical data sheet

Clamp clip, single, A2 metal pressure trough

Item number: 1159746



Dimensions

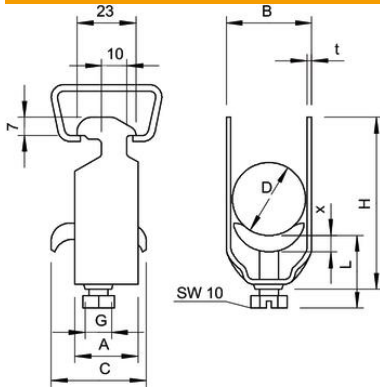

Dimension A	23 mm
Dimension B	51 mm
Dimension C	35 mm
Dimension G (mm)	M8
Dimension H	79 mm
Dimension L	44 mm
Dimension t	2 mm
Dimension x	5 mm

Technical data

Number of cables/pipes	1
for 1 cable H	79 mm
for 1 cable L	44
For pipe diameter, max.	40 mm
For pipe diameter, min.	40 mm
for rail with slot width (with interval), max.	17 mm
for rail with slot width (with interval), min.	16 mm
Halogen-free	no
Max. Tightening torque	5 Nm
With plastic trough	no
With metal trough	yes
Mounting type	Profile rail
Impact-resistant	no
Clamping range D, max.	46 mm
Clamping range D, min.	40 mm
Surface addition	Untreated
Material addition	Rustproof steel
With counter-trough	no
Material of trough	Rustproof steel
Material quality of trough	Stainless steel 304 (1.4301)