

Technical data sheet

Junction box T60, plug-in seal, elevated cover

Item number: 2007710

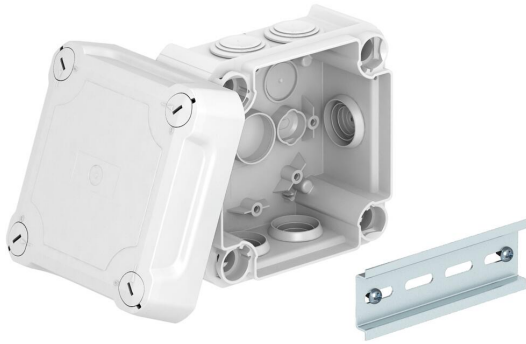

Junction box for the connection of cables and lines indoors and in protected outdoor areas. Square design with plug-in seals to the sides and knock-out entries in the bottom. Suitable for wall and ceiling mounting and on mounting panels. With the option to fasten inside and to mount via the corner domes. High cover with quick lock, sealable. Made from halogen-free and UV-resistant materials.

With hat profile rail.

Junction box according to DIN EN 60670. Flame-resistant to DIN EN 60695/2/11, test temperature 650 °C. Impact resistance IK07 according to DIN EN 50102. Clear internal dimensions: 100x100x65 mm



PP/PC Polypropylene / polycarbonate

Master data

Item number	2007710
Type	T 60 HD LGR
Description 1	Junction box
Description 2	with raised cover
Manufacturer	OBO
Dimension	114x114x76
Colour	Light grey; RAL 7035
Material	Polypropylene / polycarbonate
Smallest sales unit	1
Unit of quantity	Piece
Weight	17.18 kg
Weight unit	kg/100 pc.
CO2 Footprint (GWP) Cradle-to-Gate	0,8657 kg CO2e / 1 Piece

Technical data sheet

Junction box T60, plug-in seal, elevated cover



Item number: 2007710

Dimensions

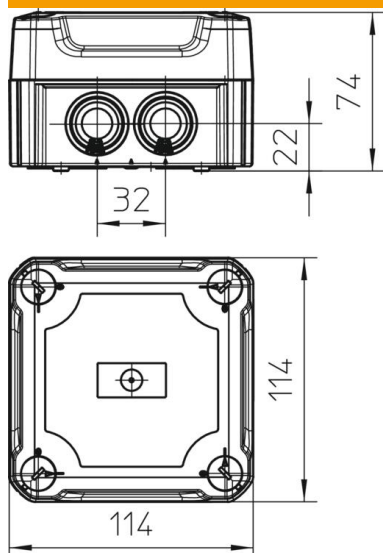

Length	114 mm
Width	114 mm
Height	74 mm

Technical data

Expandable	yes
No. of entries	7
Type of entry	Plug-in seal
Type of entry	Cable
Type of housing penetration	Miscellaneous
Measured insulation voltage V_i	500 V
Equipment	Support rail
Cover	Not transparent
Cover fastening	Screwed
Entry from rear	yes
Entries	7xM25
Explosion-tested version	no
Flame-resistant	acc. to VDE 0471/DIN 695 Part 2-1, test temperature 650°C
Shape	Square
Maintain electrical functions	Without
For Ex zone	Without
For Ex zone gas	Without
For Ex zone dust	Without
Halogen-free	yes
Clear internal dimensions	100x100x65 mm
With screening	no
with lid	yes
Mounting type	Wall/ceiling mounting
Nominal voltage	500 V
Sealable	yes
Protection rating	IP66
Protection rating IK code	IK07.
Permitted temperature range, max.	60 °C

Technical data sheet

Junction box T60, plug-in seal, elevated cover

Item number: 2007710



Technical data

Permitted temperature range, min.	-5 °C
Transparent lid	no
Weatherproof	no