

Technical data sheet

Junction box T40, with knock-out entries, with terminal strip

Item number: 2007904



Junction box for the connection of cables and lines indoors and in protected outdoor areas. Square design with knock-out entries to the sides and knock-out entries in the bottom. Suitable for wall and ceiling mounting and on mounting panels. With the option to fasten inside and to mount via the corner domes. With fixed clamping cover. Made from halogen-free and UV-resistant materials. Junction box according to DIN EN 60670. Flame-resistant to DIN EN 60695/2/11, test temperature 650 °C. Impact resistance IK07 according to DIN EN 50102.



Clear internal dimensions: 77x77x46 mm



PP Polypropylene

Master data

Item number	2007904
Type	T 40 M20 KL
Description 1	Junction box
Description 2	M20 entry + terminal strip
Manufacturer	OBO
Dimension	90x90x52
Colour	Light grey; RAL 7035
Material	Polypropylene
Smallest sales unit	5
Unit of quantity	Piece
Weight	8.2 kg
Weight unit	kg/100 pc.
CO2 Footprint (GWP) Cradle-to-Gate	0,3141 kg CO2e / 1 Piece

Technical data sheet

Junction box T40, with knock-out entries, with terminal strip

Item number: 2007904



Dimensions

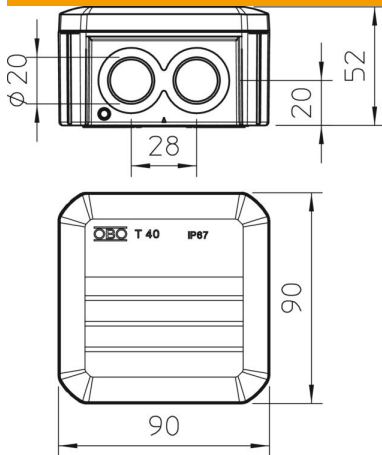

Length	90 mm
Width	90 mm
Height	52 mm

Technical data

Expandable	yes
No. of entries	7
Number of terminals	5
Type of entry	Plug-in seal
Type of entry	Gland
Type of housing penetration	Pre-marking
Measured insulation voltage V_i	500 V
Equipment	Terminal
Cover	Not transparent
Cover fastening	Locking
Entry from rear	yes
Entries	7 x $\varnothing 20$
Explosion-tested version	no
Flame-resistant	acc. to VDE 0471/DIN 695 Part 2-1, test temperature 650°C
Shape	Square
Maintain electrical functions	Without
For Ex zone	Without
For Ex zone gas	Without
For Ex zone dust	Without
Fibre-glass reinforced	no
Halogen-free	yes
Clear internal dimensions	77x77x46 mm
With screening	no
with lid	yes
Mounting type	Wall/ceiling mounting
Nominal cross-section, min.	4 mm ²
Nominal voltage	500 V
Sealable	yes
Protection rating	IP67
Protection rating IK code	IK07.
Permitted temperature range, max.	60 °C

Technical data sheet

Junction box T40, with knock-out entries, with terminal strip

Item number: 2007904



Technical data

Permitted temperature range, min.	-5 °C
Transparent lid	no
Weatherproof	no