

Technical data sheet

Reduction, PG thread

Item number: 2030705

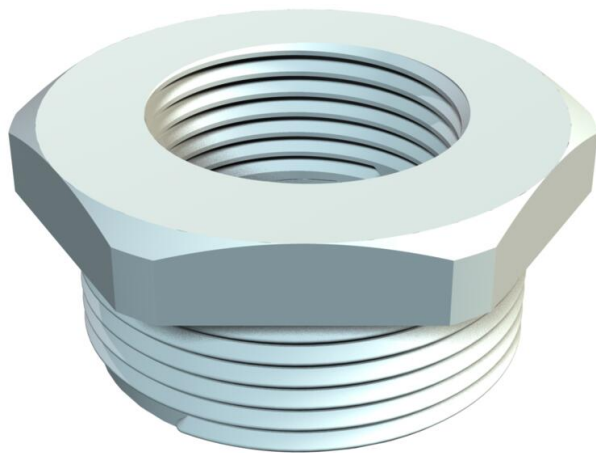

Reduction with PG internal and external thread to DIN 40430 for mounting plastic cable glands on enclosures. Protection class IP54 without additional connecting seal. Protection class up to IP68 possible with additional connecting seal, e.g. O-ring or flat sealing ring.



PA Polyamide

Master data

Item number	2030705
Type	107 R PG11- 7 PA
Description 1	Reduction
Manufacturer	OBO
Dimension	PG11-PG7
Colour	Light grey; RAL 7035
Material	Polyamide
Smallest sales unit	50
Unit of quantity	Piece
Weight	0.4 kg
Weight unit	kg/100 pc.
CO2 Footprint (GWP) Cradle-to-Gate	0,0285 kg CO2e / 1 Piece

Technical data sheet

Reduction, PG thread

Item number: 2030705



Dimensions

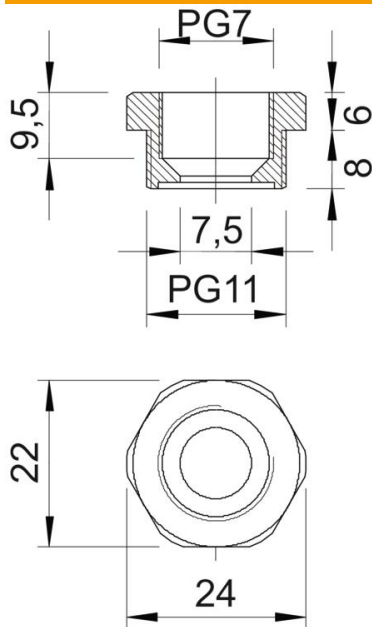

Dimension D	7.5 mm
Dimension E	24 mm
Dimension L1	8 mm
Dimension L2	6 mm
Dimension L3	9.5 mm

Technical data

explosion-proof	no
Thread type: External thread	PG
Thread type: Internal thread	PG
Thread length	8 mm
Thread dimension, PG, external	11
Thread dimension, PG, internal	7
Halogen-free	yes
WAF	22
Nickel-plated	no