

Technical data sheet

Pipe end cap, splittable, metric, light grey

Item number: 2047839



Separable pipe end cap to slot onto metric electrical installation pipes. The separable pipe end cap can be used for repairs on existing installations according to regulations. It is not necessary to disconnect the cables, allowing quick mounting.



PE Polyethylene

Master data

Item number	2047839
Type	129 TB M25
Description 1	Pipe end sleeve, separable
Description 2	metric
Manufacturer	OBO
Dimension	M25
Colour	Light grey; RAL 7035
Material	Polyethylene
Smallest sales unit	50
Unit of quantity	Piece
Weight	0.5 kg
Weight unit	kg/100 pc.
CO2 Footprint (GWP) Cradle-to-Gate	0,0181 kg CO2e / 1 Piece

Technical data sheet

Pipe end cap, splittable, metric, light grey

Item number: 2047839



Dimensions

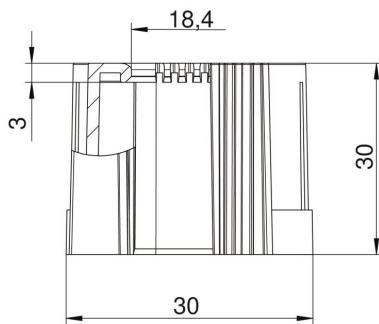

Dimension D1	30 mm
Dimension D2	18.4 mm
Dimension L1	30 mm
Dimension L2	3 mm

Technical data

Version for pipe diameter	Connector
Size	25 mm
Halogen-free	M25
Brushed surface	yes
Polished surface	no