

Technical data sheet

Pressure ISO clip 3052, single, light grey

Item number: 2101068



With adhesive base, slot and for screwing to M6 thread.
Use the Impu-Fix ribbon conductor quick adhesive, type 509, to stick the polystyrene clips to masonry and concrete.



PS Polystyrene

Master data

Item number	2101068
Type	3052 LGR
Description 1	Pressure ISO clip
Manufacturer	OBO
Dimension	24-34mm
Colour	Light grey; RAL 7035
Material	Polystyrene
Smallest sales unit	25
Unit of quantity	Piece
Weight	1.29 kg
Weight unit	kg/100 pc.
CO2 Footprint (GWP) Cradle-to-Gate	0,0524 kg CO2e / 1 Piece

Technical data sheet

Pressure ISO clip 3052, single, light grey

Item number: 2101068



Dimensions

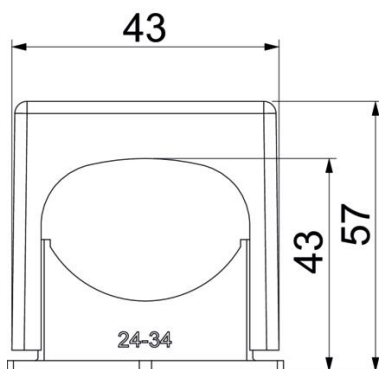
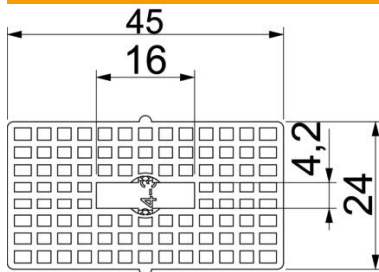

Dimension a	45 mm
Dimension a1 (mm)	16 mm
Dimension b	24 mm
Dimension b1	4.2 mm
Dimension c	43 mm
Dimension d	43 mm
Dimension e	57 mm

Technical data

Expandable	no
Number of cables/pipes	1
Fastening type	Screw hole
Halogen-free	yes
Snap system	yes
Impact-resistant	yes
Clamping range D, max.	34 mm
Clamping range D, min.	24 mm