

Technical data sheet

Snap clip

Item number: 2148021



With moulded-on push-fit plug for rapid mounting in concrete walls and masonry. Push plug into hole until the clip makes contact with the surface. When the pipe is pressed into the clip, the arms of the clip grip it.



PA Polyamide

Master data

Item number	2148021
Type	1975 12-15
Description 1	Snap clip
Manufacturer	OBO
Dimension	12-15mm
Colour	Light grey; RAL 7035
Material	Polyamide
Smallest sales unit	100
Unit of quantity	Piece
Weight	0.251 kg
Weight unit	kg/100 pc.
CO2 Footprint (GWP) Cradle-to-Gate	0,011 kg CO2e / 1 Piece

Technical data sheet

Snap clip

Item number: 2148021



Dimensions

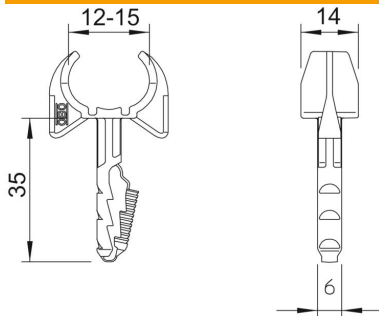

Technical data

Number of cables/pipes	1
Version for	Closed
Fastening type	Plug fastening
Drill hole depth	40 mm
Drill hole diameter, min.	6 mm
Breaking load for concrete B25	90 N
Halogen-free	yes
Clamping range D, max.	15 mm
Clamping range D, min.	12 mm