

Technical data sheet

Grip collection clamp, metal 15 A4

Item number: 2207132



Metal grouped support for high mechanical stability, even in case of fire. Suitable for safe mounting above fire protection ceilings. Also approved as a cable-specific variant for the maintenance of electrical function to DIN 4102 Part 12. For wall and ceiling mounting. Lock can be opened without tools. Detailed information on the approved routing variants can be found in the appropriate testing documentation.



A4 Stainless steel

2B Bright, treated

Master data

Item number	2207132
Type	2031 M 15 A4
Description 1	Grip collecting clamp
Manufacturer	OBO
Dimension	15x NYM3x1,5
Material	Stainless steel 1.4571
Surface	Bright, treated
Surface standard	
Smallest sales unit	50
Unit of quantity	Piece
Weight	3 kg
Weight unit	kg/100 pc.
CO2 Footprint (GWP) Cradle-to-Gate	0,2224 kg CO2e / 1 Piece

Technical data sheet

Grip collection clamp, metal 15 A4

Item number: 2207132



Dimensions

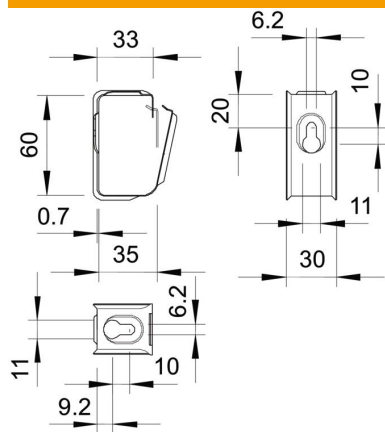

Technical data

No. of conductors NYM 3 x 1.5	15
Maintain electrical functions	yes
Halogen-free	yes
With anchor	no