

Technical data sheet

Adhesive clip 2026, pure white

Item number: 2228420



Adhesive clip, for clamping to the cable.



PP Polypropylene

Master data

Item number	2228420
Type	2026 18 RW
Description 1	Self-retaining clip
Manufacturer	OBO
Dimension	7-12mm, L18
Colour	Pure white; RAL 9010
Material	Polypropylene
Smallest sales unit	100
Unit of quantity	Piece
Weight	0.097 kg
Weight unit	kg/100 pc.
CO2 Footprint (GWP) Cradle-to-Gate	0,0037 kg CO2e / 1 Piece

Technical data sheet

Adhesive clip 2026, pure white

Item number: 2228420



Dimensions

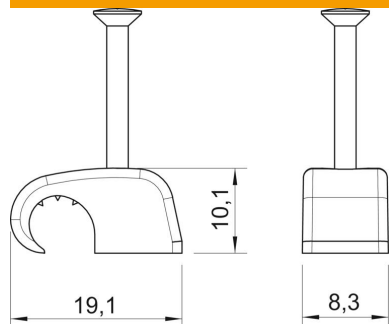

Dimension B	8.3 mm
Dimension H	10.1 mm
Dimension L	19.1 mm

Technical data

Double clip	no
Shape	Round (for round conductor)
for cable diameter, max.	12 mm
for cable diameter, min.	7 mm
For nail diameter	2,0 x 18
Hardened	yes
Halogen-free	yes
With nail	yes
Nail length	18 mm
Impact-resistant	yes
Pipe locking	no