

# Technical data sheet

## Connection clamp for earth rod, universal FT

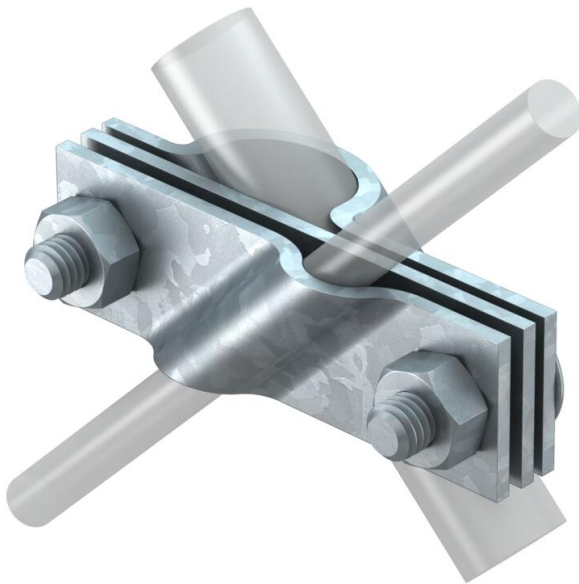

Item number: 5001641



- Suitable for attaching round conductors Rd 8-10 or flat conductors to FL 40
- With separator plate
- Installed with 2 hexagonal bolts M10 x 30 and 2 hexagonal nuts M10



**St** Steel

**FT** Hot-dip galvanised

### Master data

Item number	5001641
Type	2760 20 FT
Description 1	Connection clamp
Description 2	for round and flat conductors
Manufacturer	OBO
Dimension	20mm
Material	Steel
Surface	Hot-dip galvanised
Surface standard	DIN EN ISO 1461
Smallest sales unit	5
Unit of quantity	Piece
Weight	27.5 kg
Weight unit	kg/100 pc.
CO2 Footprint (GWP) Cradle-to-Gate	0,7017 kg CO2e / 1 Piece

# Technical data sheet

## Connection clamp for earth rod, universal FT

Item number: 5001641



### Dimensions

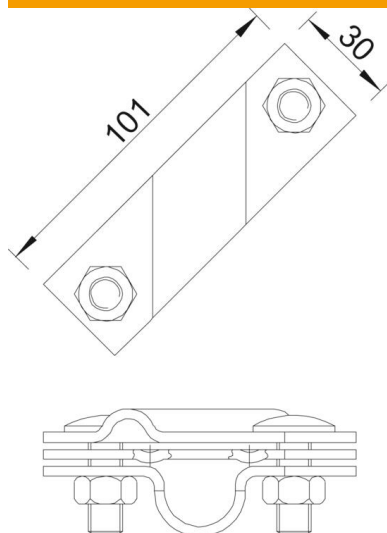

Dimension A | 101 mm

### Technical data

Type	Connection clip
Earthing connection diameter for earth rods	20 mm
Suitable for round conductor diameters, max.	20 mm
Suitable for round conductor diameters, min.	10 mm
Short-circuit current (50 HZ)(1 s; $\leq 300^{\circ}\text{C}$ )	8 mm
Fit	7.9 kA
Intermediate plate	Rd 8-10/FL40 mm
Clamping range, max.	yes
Clamping range, min.	10 mm
	8 mm