

Technical data sheet

Connection terminal to 14 mm

Item number: 5318084



- Flange thickness to 8 and/or 14 mm
- With 4 hexagonal bolts M8
- Conforms to the requirements according to DIN V VDE V 0185-3, Section 4.5



SG

cast steel

FT

Hot-dip galvanised

Master data

Item number	5318084
Type	272 8
Description 1	Terminal
Manufacturer	OBO
Dimension	8mm
Material	cast steel
Surface	Hot-dip galvanised
Surface standard	DIN EN ISO 1461
Smallest sales unit	20
Unit of quantity	Piece
Weight	22.8 kg
Weight unit	kg/100 pc.
CO2 Footprint (GWP) Cradle-to-Gate	0,4703 kg CO2e / 1 Piece

Technical data sheet

Connection terminal to 14 mm

Item number: 5318084



Dimensions

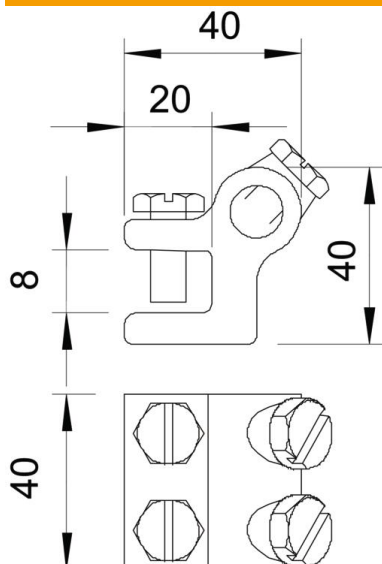

Technical data

Type of fastening screw	Hexagonal bolt
Type of connector	Connection terminal
Lightning current carrying capacity	N/50 kA
Suitable for connection	Round conductor Rd 8–10 / Rd 8–10
Fit	Rd 8-10 mm
Intermediate plate	no
Clamping range, max.	8 mm